



S" #% & #
#) " __wS&S__ v #' ž

")' ' žSS#(S%##
" S#ž #' * " S*#
" #' ž*' () *" &
" S%ž*+"%*') (

Zffb,!!i i i ž adVg` [a` žā_ žU
Zffb,!!V/VTāžā_ li adVg` [a` #++%



Contents



7

- 7.1
- 7.2
- 7.3



8

" "

8.1

" " "

8.2

10

10.1

COPY



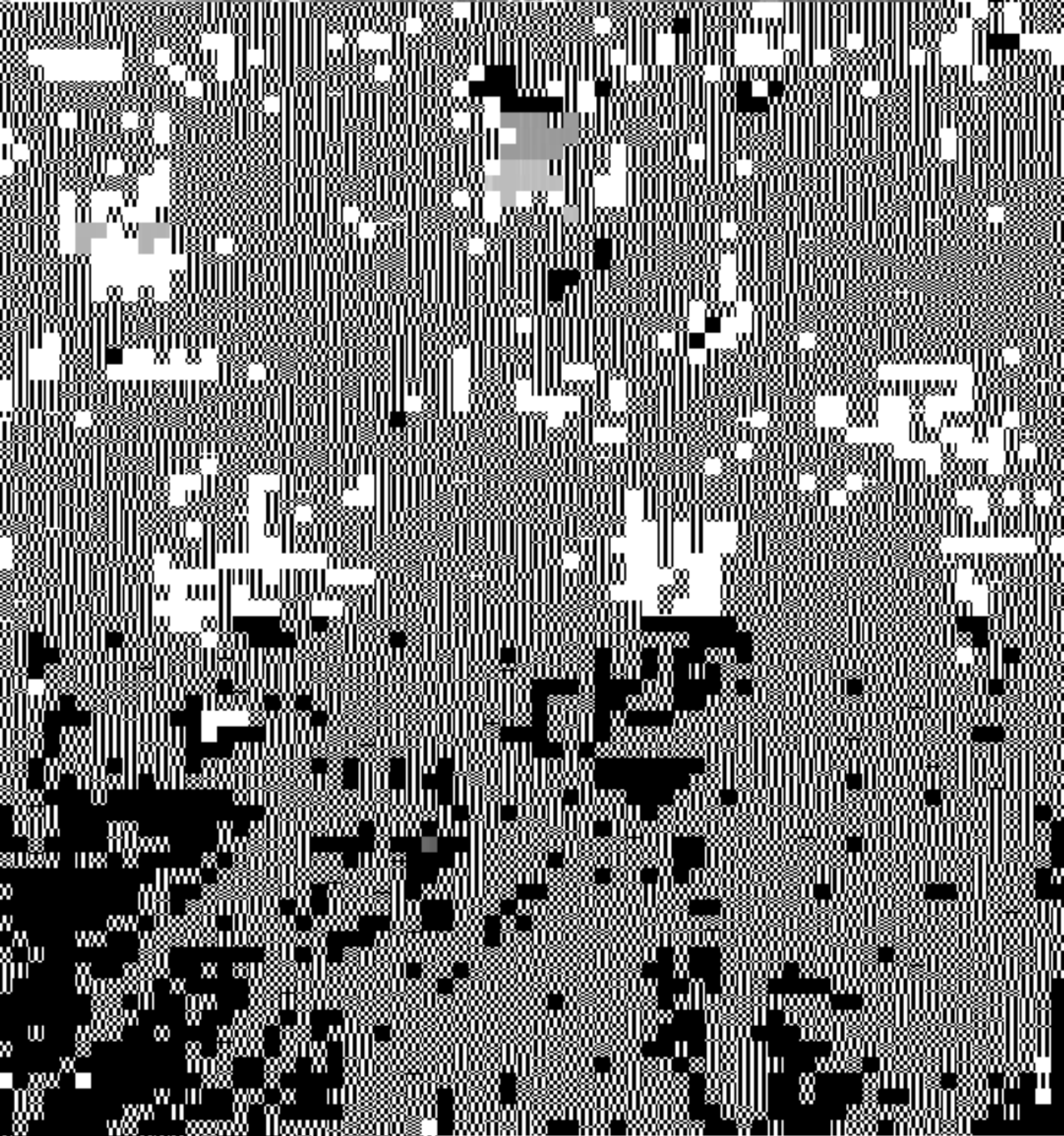

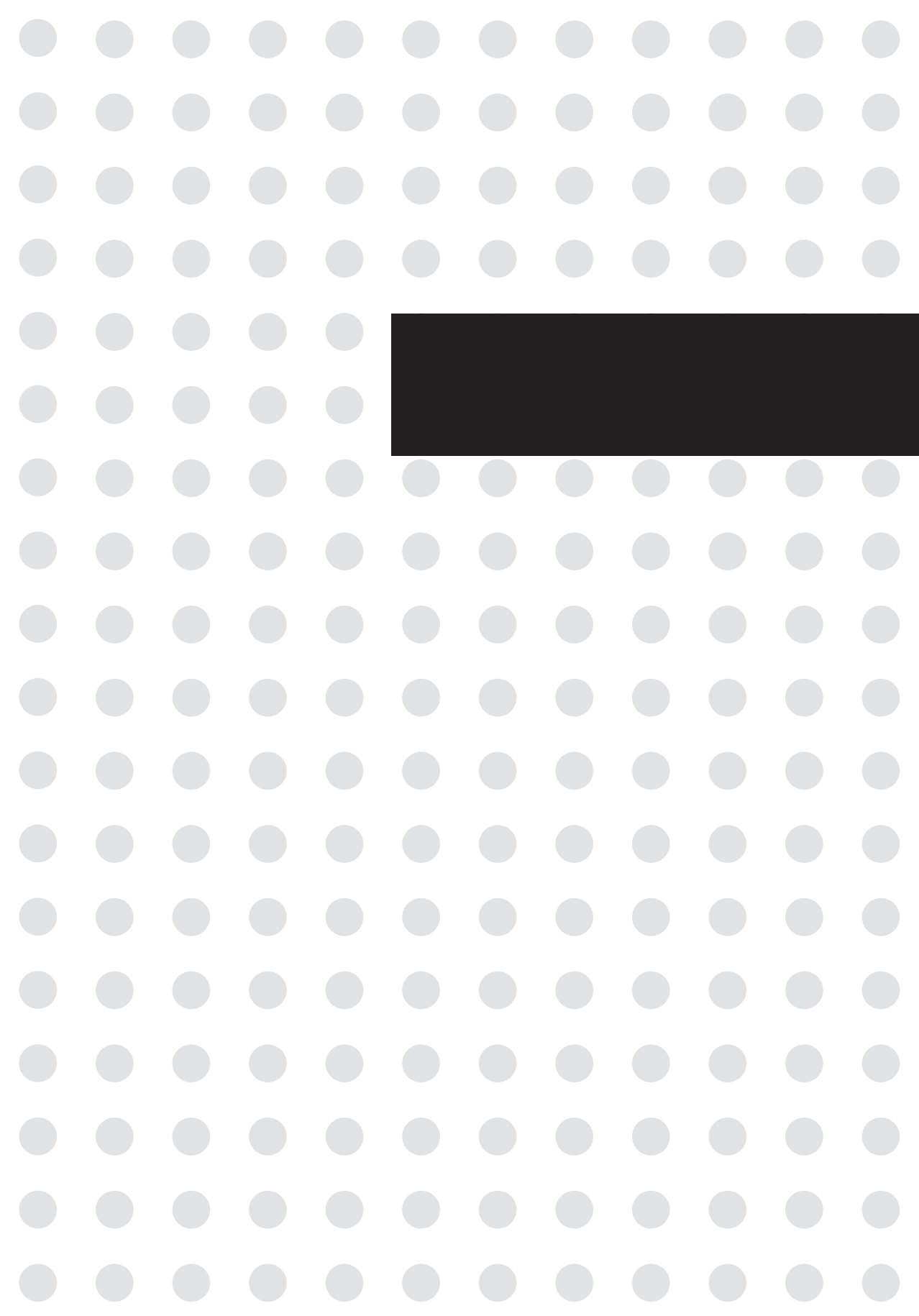



1

Tai `

Tai `

Tai ` HagəW Tai ` HagəW

1.1 " "

1.2

1.3

1.4

2

“

”



2.2 " " " "

2.3

2.4



3



CEO

3.1



3.2

— —"

"



) " " S " " 96BS " " " # " "

)T

4

" " " "



CEO

“ ”

4.1

“ ” “ ”





5

“

”

MOMA

MOMA

5.1

1





1



FA: A

3

1



6

REITs T

D7;Fe

D7;Fe

D7;Fe

6.1

6 1

REITe

	D7;Fe	D7;Fe
	" * \$%	" &"'
	\$" "' z##z\$'	\$" "' z#\$z\$#
	#" z%	%z')'
	\$#z&	#"
	%#(%

##" "

*" "" "

S" " & #S (

#" z p#" z'

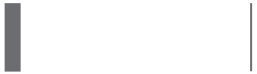

S' "

%

' #

S*'"

#%

##

S'"' ## #&

#+žS'

' "'

&+&"

+ž p#% ž%

'

+žSp+ž*

S'

#&ž (ž ##ž"

##ž'

S' ##

"

+

6.2

D7;Fe

#

\$

D7;Fe

D7;Fe

D7;Fe



7

CEO

7.1

7.2

7.3



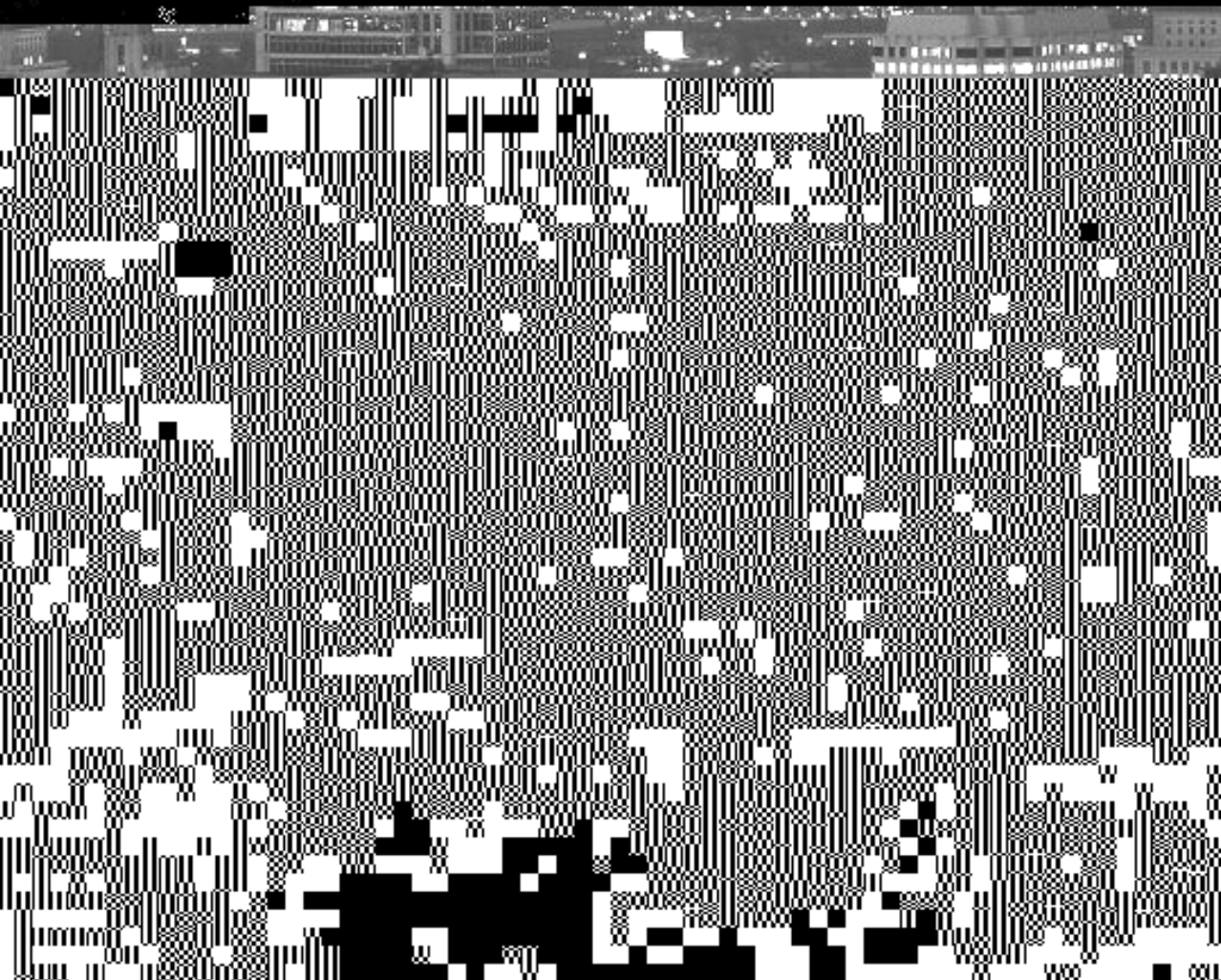

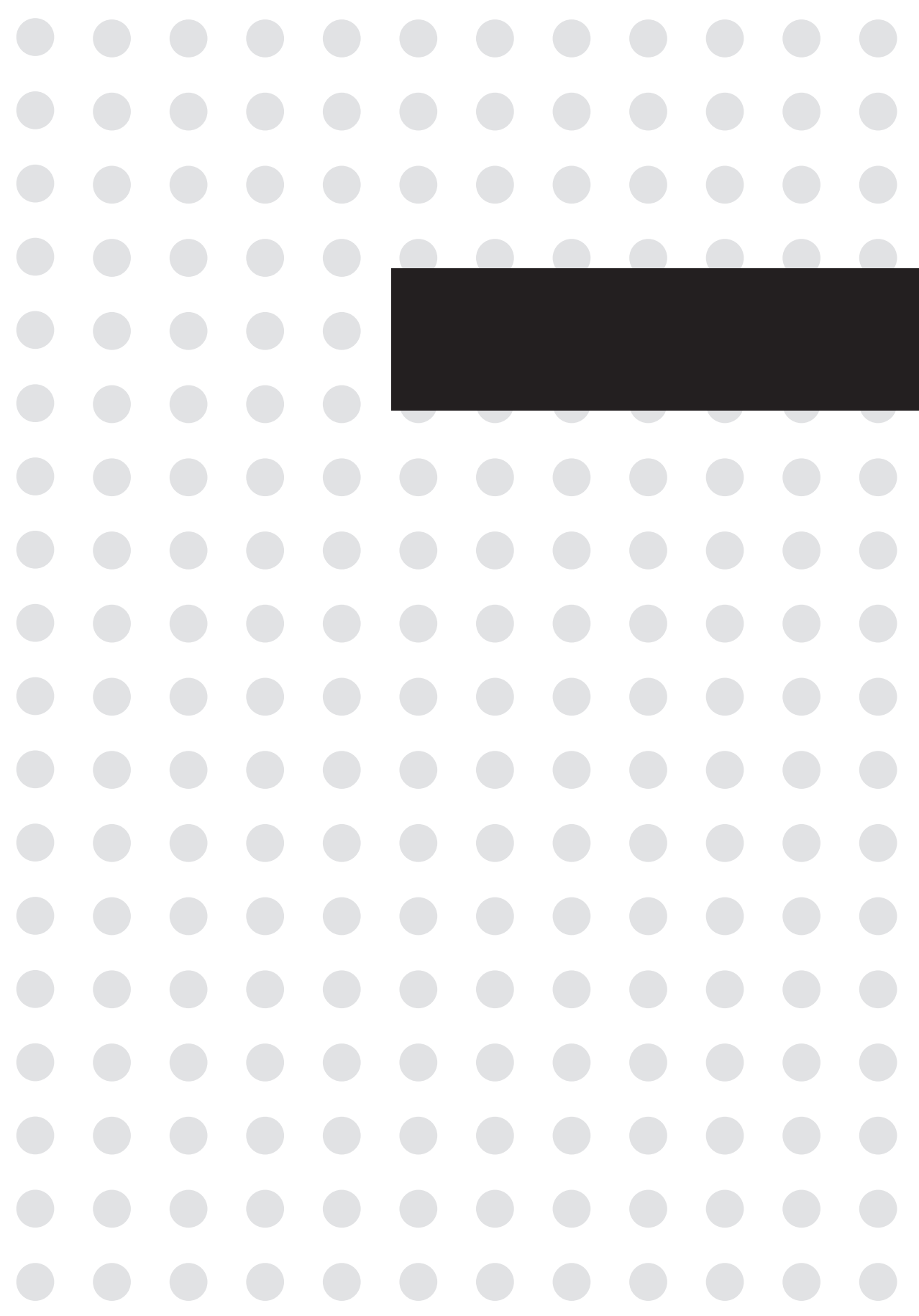

S" " S

#S

#*Z

(

%" "

S" " &

: ABE53



: W_L W_L

>agle Hg[ffa` 9gU| BδVS 8WM| 6[ad 3d_S` [LW S ? S| ? Sδ : gYa
4ae HME SUW

EZabb[` Y? S^

EZabb[` Y? S^

' p#

S"

*" "

)" "

#* p%

<AK 5;FK

\$" ") #S \$*

%'

#(") %

S" ž



#* p%

S" " *

+

#" "



*Z#

\$" "#) #&

\$" " (

8 1

	\$" "#)
	#\$((



8-2

40

18

"# # AF544 : >BBK

S" #S

" (ž

#++"

S" #S

%'

S" #' (

S" ## *

S" ## +



' "

8 4

	\$" #	&"	' '	#* Z*	%&
	\$" # " Z ' "	' "	' '	\$&	&&
	\$" ") # \$	&"	\$"	#"	' " .
	\$" # # # \$	' "	' %	\$)	' # .
	\$" " # Z)	("	#%&	' z&	&" .
	\$" " + Z (\$"	\$)	# \$	&&

8.2

#' "

)p#'

8.2.1

"

"

S) ž\$ S" ## ') ž#.

%Z*

)Z(

#+Z*

S" #"

S" "+

(Z



9dS` V 9SfW/Sk ((

#++S #S

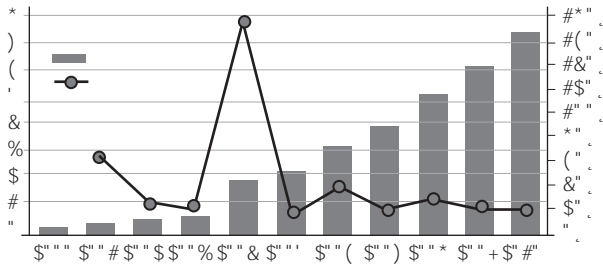

8 6

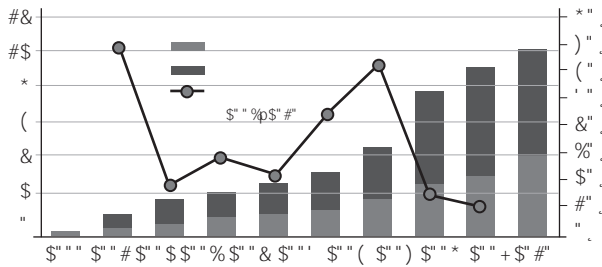

#

\$

#+++

&&*

)'.

8.2.2

S" ") S"##

+"ž (S# ž*

' #Sž* ##*ž#

S" "&

("

8.2.3

1.

S" "&

#

%"



8 8

2. " "

#++S

#+++ S" "#

S" "%

S" "'

&" "

#*

8 5

	#++%Z#\$		\$)% "" #++&Z##	\$" "#Z) ("
	#++\$Z#\$		#(' "" #++'	#+++Z#\$ "\$
	\$"' Z' +		#*#" "\$ (Z' +	\$" "#Z (%
	\$" "(Z' *		*&\$&" "\$ ")Z' &	\$" ## #" "
	\$" ")Z' \$		#)#" "\$ "\$ ")Z#\$	\$" ##Z' * %
	\$" "+Z' '		\$\$\$" "\$ \$" "#Z' +	\$" #' &
	\$" "' Z' %		#' %" "\$ "\$ "*Z' '	\$" #' %\$
	\$" "(Z#\$		\$(&" "\$ "\$ "*Z#\$	\$" #% %
	\$" "+Z' '		##%" "\$	\$" %
			#+&(&" "	%)

#+*\$

#++)

###

\$"' '\$

&

Z%

\$'

\$" "* ' '

\$" #

\$" ")

&

%

\$" ") \$" "*

\$" "+ ' '



+ (\$" "

3. " " \$" " (\$" ") \$" "*" \$" "+ \$" # " \$" ## ' S

8 6

				\$+	##%	\$" #% 7
			\$"	' &	#(\$" #% 7
				#" '		

"ž p#ž (ž p*ž

' "

\$" " p' " "

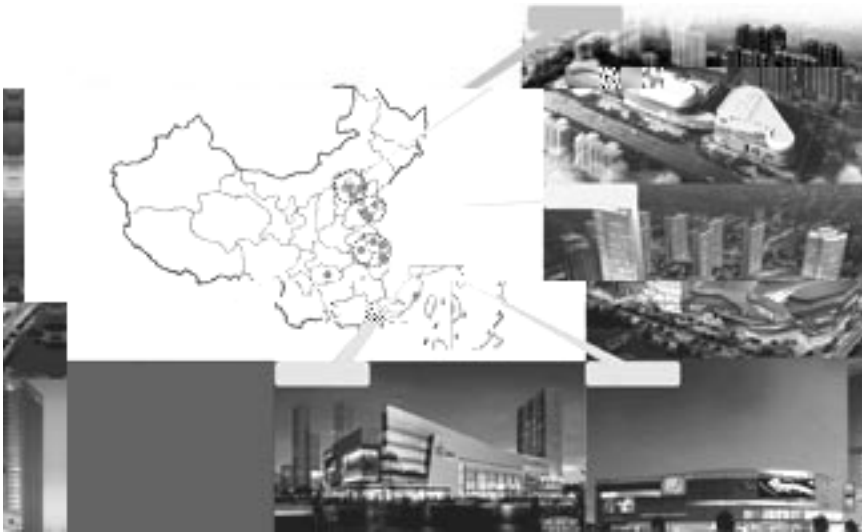

8-9

*Ž+

\$" #%

%

8-8

)"	\$"	\$" "(Z#"	\$" ##Z')
		#&Z\$	*Z	\$" ##Z'	\$" #%
		\$"	\$"	\$" ##Z##	\$" #%
		#%*	\$"	\$" #Z\$ %	\$" #&
		')Z(\$" #Z	

2.





S" #' #'

S" #S '

S" #S

&pi

S" #

#

8.3

8.3.1

S" "(+

&Z%

#&

' "

(" ,

&" ,

##" "

v

>76

? S^

S" "()

' ""

' " ,

S" ") #'



S" #'

S

#'

*" ""

%p' ""

#*pS(

#Z

S"

8.3.2

S" " S +



EZabb[Y? S^

\$

%+

(Z'

%

\$" "(

+ ' .

\$

\$" "'

%

#" "

\$" "(

%'

,

\$" "

\$" "' (

%'

#\$ #)

%'



\$"") #

\$"

8.3.3

S"

#"

#++*

+

S)



3? 5

S" " (# (#ž
 ' " ' "
 #S%ž%
 #S" ž #ž* S #
 S" #' #S #) #ž S" ## * #*
 #(ž%
 S" #'
 #* +pS" * S" #' & #
 S" #' & S(' ' S ;BA
 #& % ' S ;BA
 +ž#
 S" ž ' pSSž &



9

9.1



9.1.1

1. SOHO



“ ”

EA: A

EA: A

EA: A

EA: A E A:



SOHO

EA: A

S"")

&(ž-

#S

S" "*

S" "* (

EA: A

&

E": A

S" "*)

S" "*) #+

EA: A

&ž

&ž

!

S" "*

)"

S"")

S" "*

S" "+ * %'

EA: A

#+S"

#(ž*

#(



EA: A

EA: A

2.

EA: A

EA: A

9-1 SOHO

	EA: A	EA: A	EA: A

9-2 SOHO

	EA: A	EA: A	EA: A	EA: A	EA: A

EA: A

3.

EA: A

EA: A

\$"

\$"

&"

,

#" "

EA: A

EA: A

9.1.2

EA: A

H_i>>39 EA: A

H_i>>397 3



#+

EA: A & EA: A

9.1.3

1.

EA: A





90'



)".

#%" "

#

\$

%



#(

(ž

#ž#

#ž

' ž&

&žS

* &'

(!

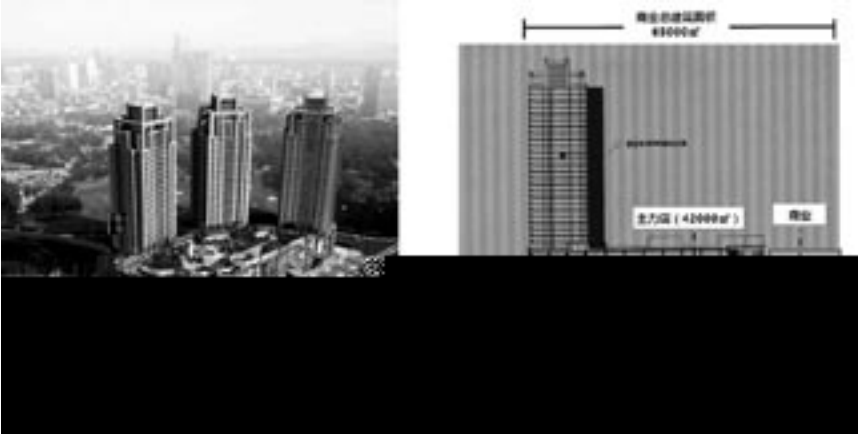

9.2

— —

9.2.1

1.



#

S" #S

9-4

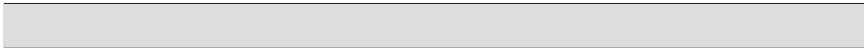

				%Z
				&Z)
\$#	#" &Z\$	%Z (#Z&
				%*
				\$#
				\$%
				&
)&&\$'	%*	' ZQ		#*
				#(
				&
#%@#@#@%	&"	%		\$"
				#(
				&Z'
##&(((&\$	%Z(#%Z' (
				\$#Z%+
				%
\$%	(*	%		%#
				%Q
#*) *	&Z#@%		\$"

\$

' "

#&"

\$" #%

* "

%'

& \$" #%

+

%

\$%"

)

\$"

9.2.2

1. —

%
 (" ' + ! ' 'S
 ' " & !
 &# " %

\$" #S

)S

'S

!

' +

("

' "

&

!

&#

"

%



#S



&

*

Ž# .

\$!

& !

9.2.3

1. " — —



96B

96B

? 3>>

96B

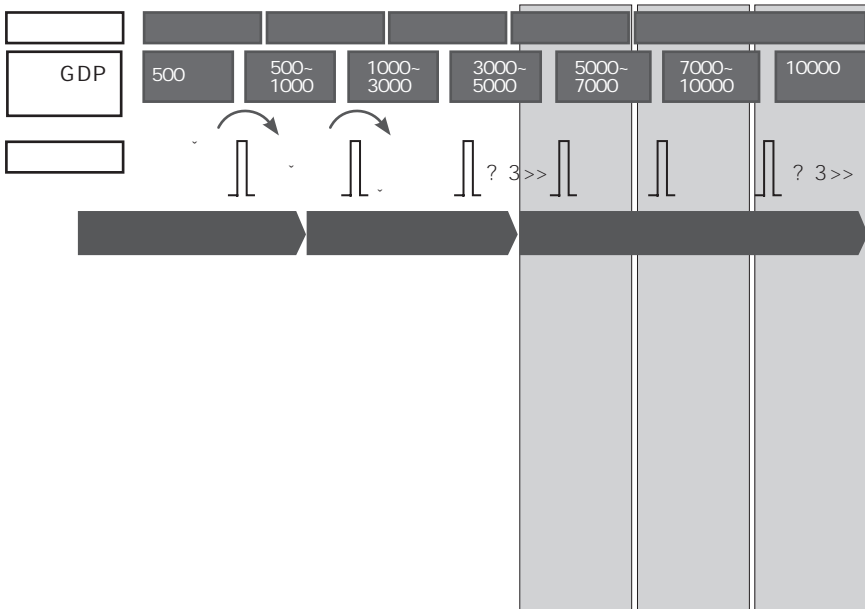

9-1

3.

S''*

%



9.3

5

9.3.1



1.

2.

/



v

)

v

9.3.2

1.



2.

S''''+

v

v

v

v

v

v



v

? 757

v

v

v



v
v
v

v

9.3.3

1.

S" #S

%~~t~~

&

1

Á

" "

"

v

v

v

"

v

v

v

v

v

? 757

v

v

v

v

v

" "



v

v

v

v

v

9.3.4





v

v

v

v

v

? 757

v

v a

v

v

v

v

+Z

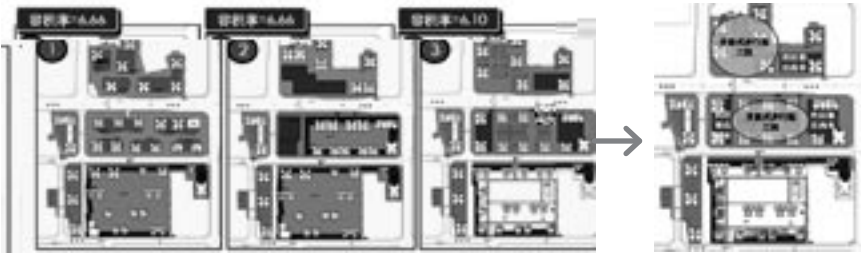

9 5

3

v

9.3.5

1.



)".
'pS"

2.

S" #S

v

v

v

v

v

v

v

v

v

v

v

v

v

v

v

v

v

v

&"

)"

v

+"



10

5ABK

10.1

COPY

10.1.1

	#+**		
\$"#\$	#"#\$	%'" "	#&#)
\$" \$	#" "	((%*
("" "	')	(%	=FH



|





+"_c

!

#'ŽS

' ""

=FH

2

ł

|

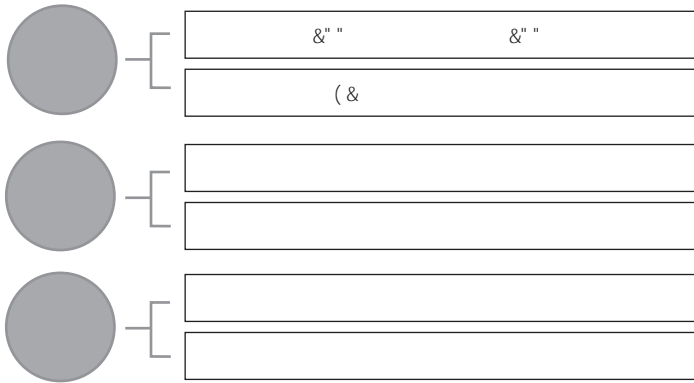

10- 5

10.1.3

!

1.



10.2

+ +

10.2.1

L L

a

!

~



£

!

10.2.2

"

"

1.

"

('

#

('

\$"

&

)" ,

3



%

2.

%





10 8

10.3.1

" "

1.

&

&

2.

— — " "

#

\$" (+)ž'

&

*



10.3.2

1.

(

'z

&S

&'

%

)

S

#'

&*

%'

""

?

&

2.

#





2.

&

#

\$





10.3.4

1.

#

\$

%

&

,

!

(

)



*

2.

#

Sž

#%

#

Tž

\$

Sž

#

: ?

Tž

&%)ž#

(+ž .

%

)' .

' .

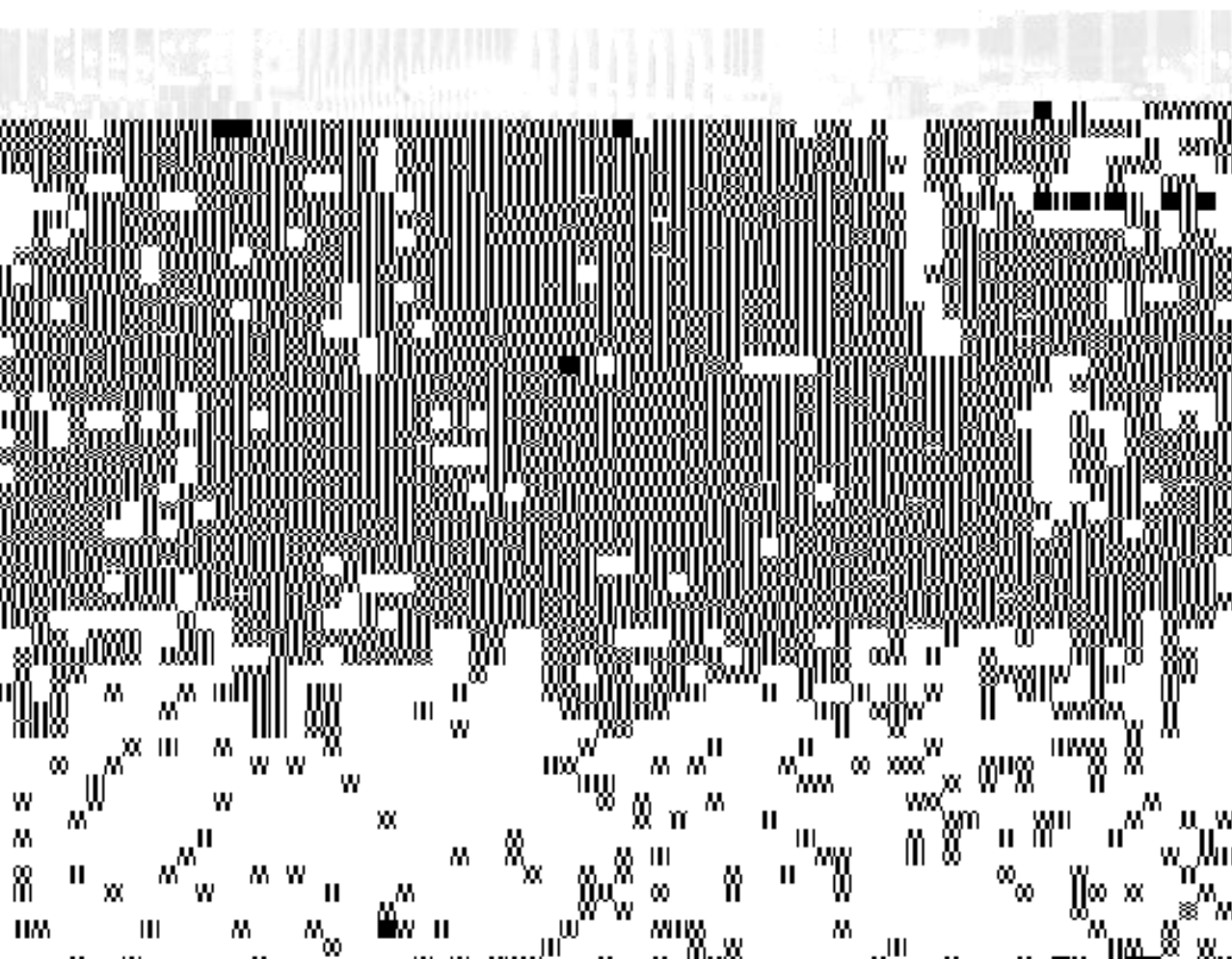

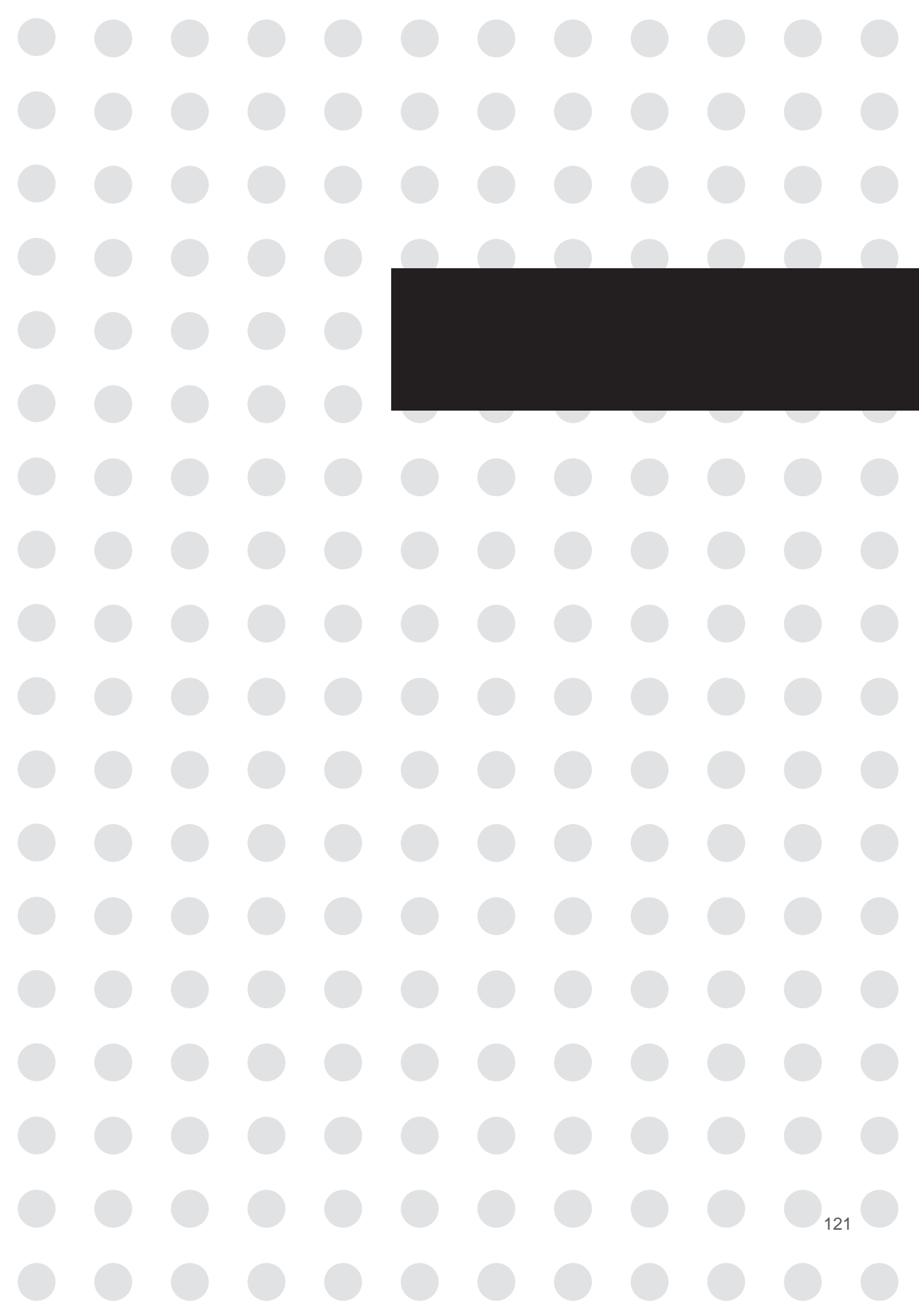



11

11.1 " REITs+ "

D7;Fe

&% #&
 % ') ' *"
 (S%
 # "

11.1.1 " "

DW 7e SW`hw` Wf Fdfe D7;Fe

1. " "
 S" #S) #' :::
 S" " (S" ") ()
)
 #Z#



##Z#
 2. " "

D7;Fe

D7;Fe

##ZS D7;Fe

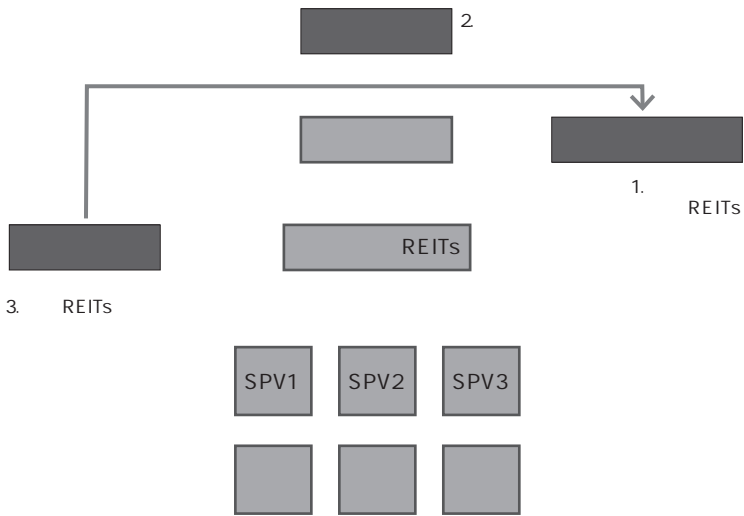

11- 2 REITe

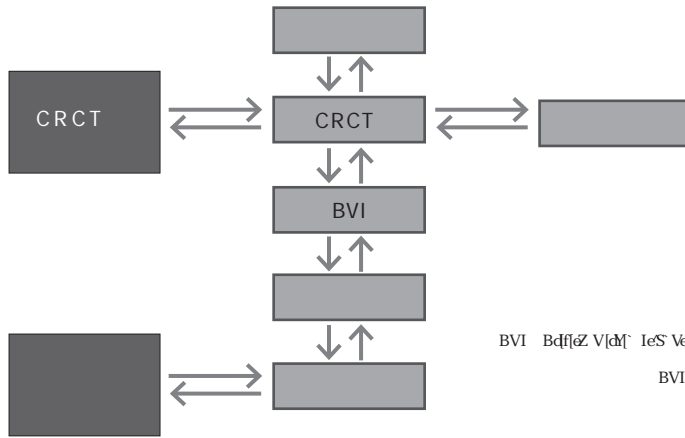

11- 3 CRCT REITe

S" "(

D7; Fe

5Sb[fSDMS[^ 5Z]^ S Fdgef

5D5F

S" "(

5D5F

S" #S 5D5F

+

5D5F\$" #S

S" #S

) (

S" #S

& .

5D5F

D7; Fe

##Z%

5D5F

5D5F

4H;

5D5F

D7;Fe

3. " 1+1 2"

D7;Fe

5D5F

5D5F



%p' .

#' .

Sp%

& p' ' .

D7; Fe

4.

? 3>>

? 3>>



11.1.2

REITs

#) #

D7;Fe

D7;Fe

D7;Fe

D7;Fe

\$" "'

D7;Fe

\$" "(

5D5F

D7;Fe

5D5F

Q

D7;Fe 5D5F

D7;Fe

#) #

D7;Fe

#Z

S" "(

5D5F

S" "*

l S" #'

*

#) #

S" #'

S,

D7;Fe

*

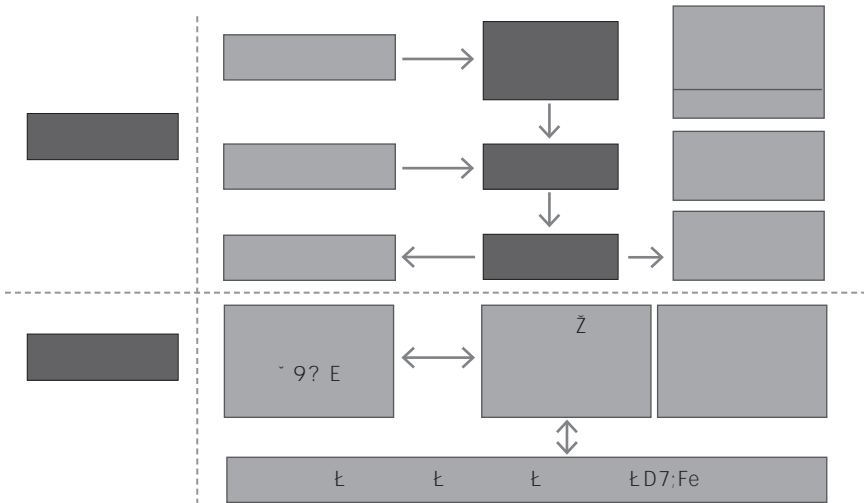

11- 5

\$" #S

S" #"

&S

#Z/g

) *ž (

S" ## #" %#

&ž(

*) " &

(*ž%#

D7;Fe

D7;Fe

11.2

"

"

#++(##

#" "

S"# % *

%

)"

11.2.1

" " "

S" "#

S" "#

#"

#"

1. " " " "



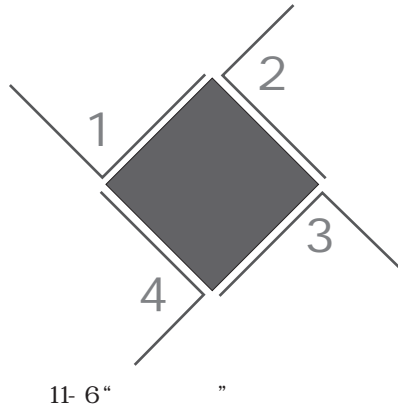



#ž

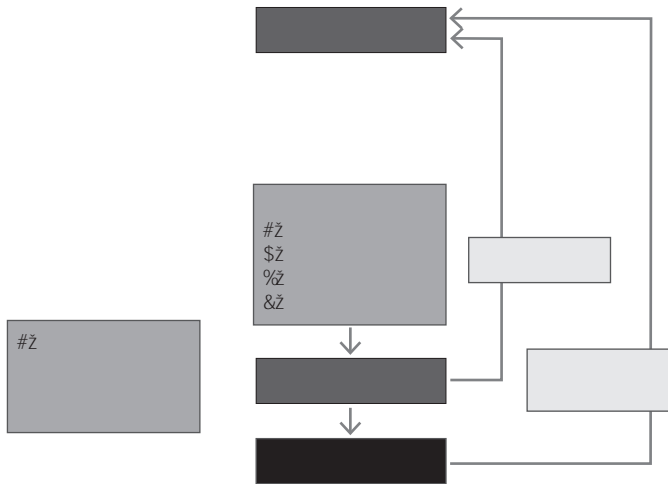
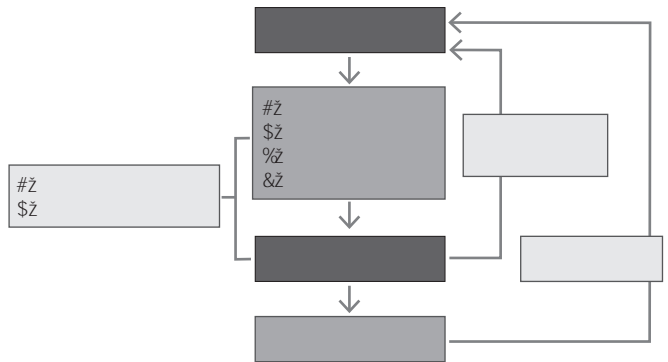

11- 7

2. " "

#fZ*



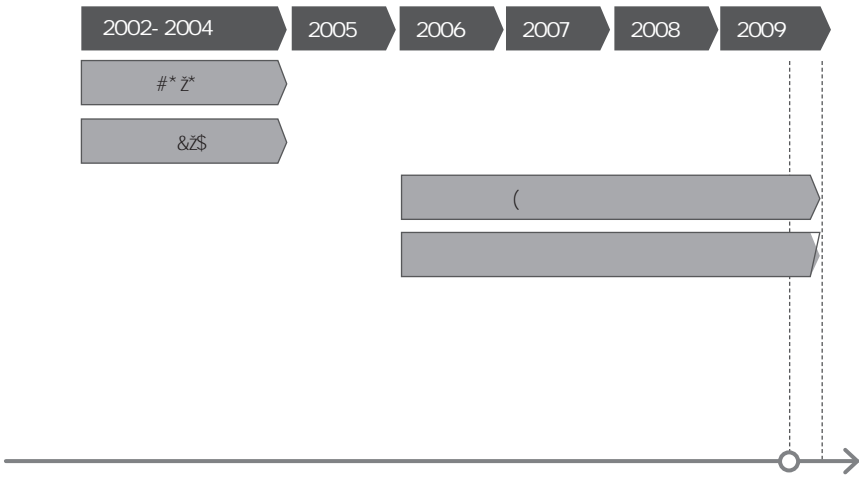

11.2.2

" "

Ł



##Z##

*

*

11.3

$\#L^{**}$ S'
 $S''\#S$ $\%''''$
 $\#&\#$ $S''S$ $\#''''$

11.3.1

$''$ $''$
 $D7;Fe$
 L

1.



S #++' p#++*

% #+++

S" "#

& S" " \$

' S" "%

S" " (

(S" "% S" " (

D7;Fe

5? 4E 5a_ WUS^? adfSYW4SU WEWgd[W

#+**

S" " (

D7;Fe

2. 5? 4E
5? 4E

5? 4E

E

E



#

S" " &

Sp&

&' p*"

##Z#S

##Z#%



11- 12

+#

;BA

S"

S"

#"

'



&

##(%
%

#% %

\$"

#"

\$

#"

#"

#(

SS

S" # (

% ,

4.

#



\$

\$''''

+

S&

3

%

\$''''%\$''''

D7;Fe

D7;Fe

\$''''

5? 4E

&

\$''''+

;BA

11.3.2



546



S" #S

%ž

Sž&#

)".

%#&

&ž.

12

12.1 8

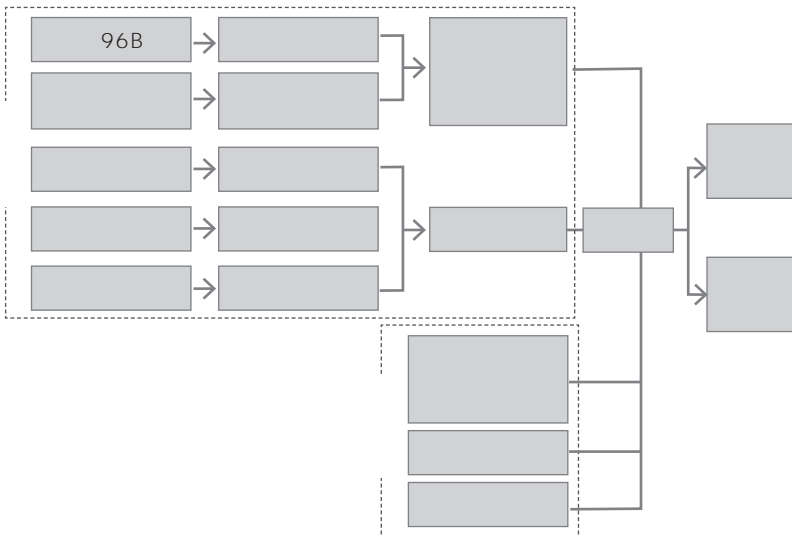

12 1

96B

12.2

12.2.1

\$" # \$

%

("

\$%

12 2

2

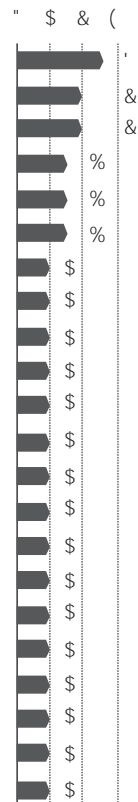

12- 2

!	&"	' '	\$#&	\$" " &#&
	' "	* "	\$&	\$" #" ' &
	&"	("	\$"	\$" ##' "
	\$"	#+&%	#" ' "	\$" #&
	\$'	\$#"	\$&&	\$" #&
	("	#&"	\$) &	\$" #&
	' ") * &	#) &	\$" #&
	((#&"	#*	\$" #&
	\$" "	#%&	#*	
	#" "	#" "	\$"	\$" #
		+	\$%	\$" #&
	' "	' ' &	\$' &	
	()	%&		
	\$'	&"		
		* "	\$"	
	#"	\$(" "		
		#" "	%"	
		&' "	\$(" "	\$" #
#)	#" " "	#&" " "	%" " "	\$ %

\$' "

(" "

GDP5000 GDP8 1000		96B	96B	
		#&' "	#&&	#% " "
		\$" #" #	* &	\$% " "
		#) * " #	* &	\$" (+
) * " &	* &+	* " "
		* #&+	' &	#&"'
		##&' +	%&+	\$+&'
		(' \$'	* &) (#

12- 3

12-4

!		
)"	&"
		#\$
	+(\$&
		#&
		&"
	&&	%#
	###	#" %
		#(

٤

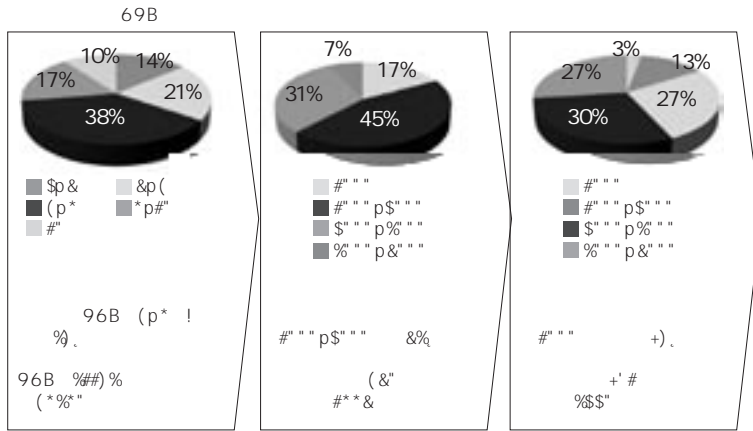

&""
 %""
 %""
 \$""
 \$""
 #""
 #
 #""

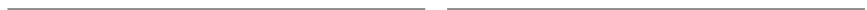



96B

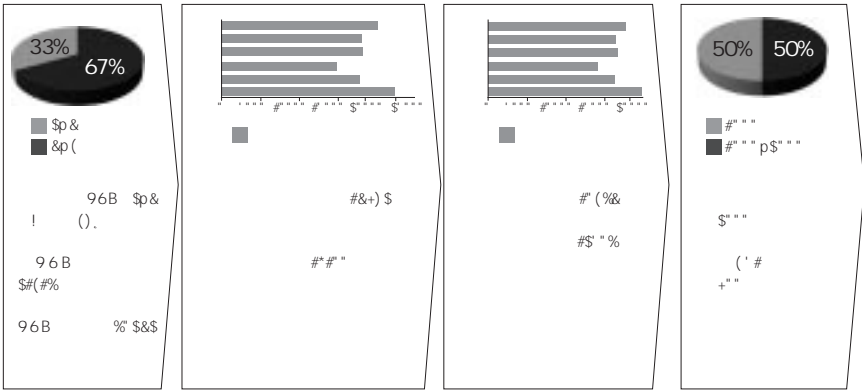

96B \$#(#%)

%\$"
#&+) \$
(%&
(' #

96B % \$&\$

&\$)
#*#"
#\$' "%
+'"

12- 5

#S

	96B
	%#) %
	%\$Q (*
	\$#(#%)



12.4

“ ”

*

12.4.1

— —

#

#

#SpS&

&

	\$" Ž %	@aha		
	\$" Ž %	#"		

12- 8

12.4.3

S" "%

#

\$

%

&

,

(
)



13



13.1

13.1.1

13 1

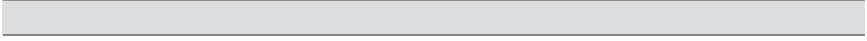

'p##' #

#'p##

\$'p("

\$'

#'

%)

& (p' '

13.1.2

13-8

!	!						
	&#	##	"	\$	"	\$*	\$*)\$
	&"	#"	'	#	#	\$	\$')'
	\$	'	#	#	'	"	' " " "
	#"	'	'	#	'	((" &"
	%	#"	#"	#	#	%	% ('
	\$	#"	#	'	#	%	&" ("
	\$	'	'	#	#	&	&" ("

1.

' " "



4

3 4

)"p#" "

&"p' " "

\$" "

3

4

3

'"p(" "

%" "

2.

13 9



%p&"

("

%"

'"p("

%!p("

3.



13.2 3

13.2.1

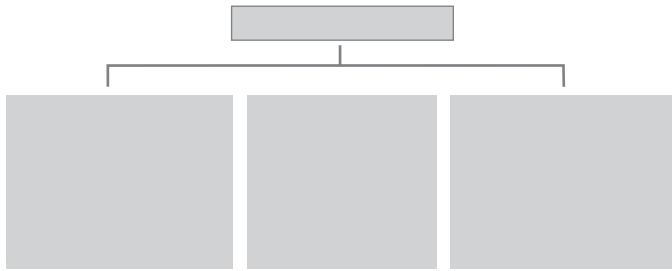

13-1

"

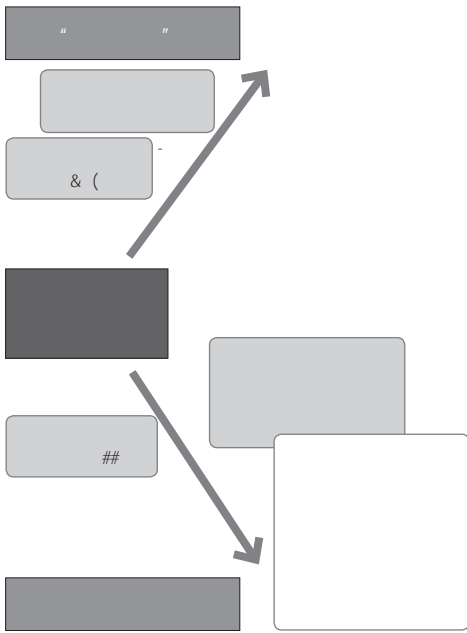

13-2

/



%Ž&₶

'"p("₶

%₶

!

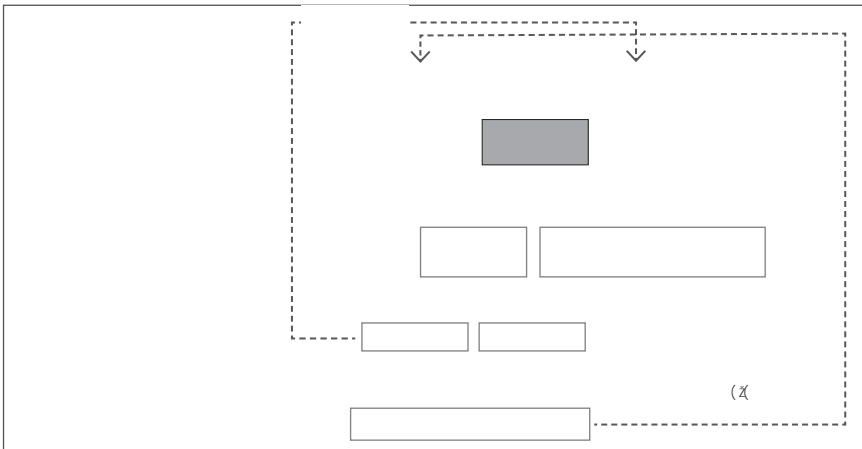

13.2.2

Ł

\$''''

+

13- 12

13- 13

	% "	(*
	# Z&	+Z)
	' ""	\$(+

#*žs#

)

)"ž*" ,

13.2.3

%

' &# '(

') (

% '

' (

#' "

#("

D7;Fe

% '

* ,



1

? 3>>

13.3 155PK 76

13.3.1

155

'

#%Ž#&

1.

#		
\$!
%		! !
&		
.	#z	
(
)		
*		
+		
#		
##		
#\$.
##%		
##&		! ! ! ! !
#		
#!		!
#)		
#*		
#+	!	
\$		
\$#		
\$\$! ! !	
\$\$%		
\$\$&	!	
\$		
\$(
\$)		
\$*	0	
\$+		
%		
%#	.	
##%		
##&		
##%		
##&		
%(
%)		
%*		
%+		
&		
&#		
&\$		
&%		
&&		
&)		
&*		
&+		
.		
·#		
·\$		
·%		
·&		
·.		
·(
·)		
·*		
·+		
·*		
(#		
(\$		
(%		
(&		
(.		
((
()		
(*		
(+		
)		
)#		
)\$		
)%		
)&		
).		
))		
))		
)*		

#

S

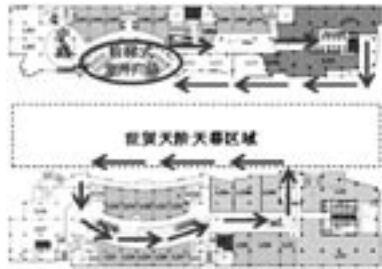

%

&





(F

F

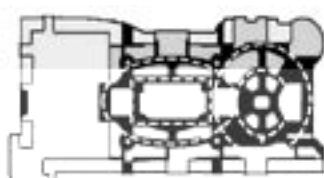
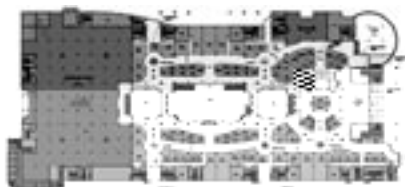

)



F

2.

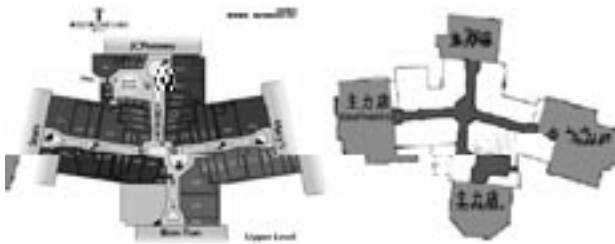

EVSdb FZW

4a` ŽFa` =SgX_ S` e <5 BW` VK

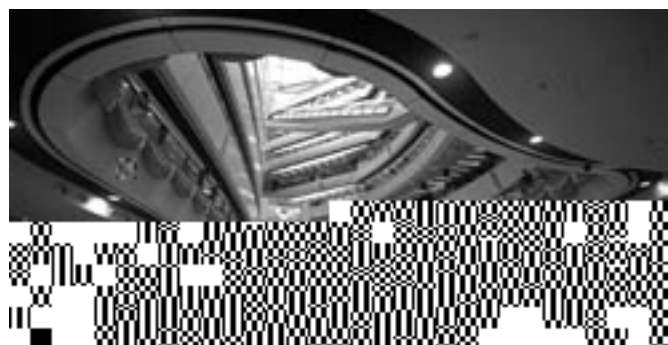



\$

%

,

\$

%



1.

2

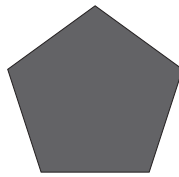

4.

>76

5.

3.

13.3.2

76

+''

)(



1.

2.

3.

f&u 4="F





7.

S" " #

#" " #p# " #

+# #

GH

8.

9.

13-17

	!	!
	% " " p & " " "	#!\$% p#!%&'
	& " " p ' " " "	#!%&' p#!&'&'
	' " " " p (" " "	#!&' p#!' %

10.

HDH

HBH



11. 5A

13-19

'3		
43E		
A 3E		
83E		
E3E		
53E		

!

14

"

"

#

\$

¿



14.1



14.1.1

! !

3.

14.1.2

! £

? 3>>#+'*

1.



#

14-1

%

#

\$

Š



14 3

	!
	ž



AgfMē

Ł

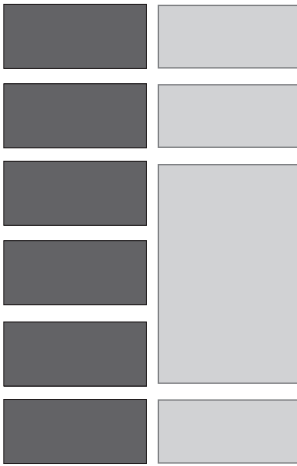

(" Ź#&"

% ""
 "" Ź)"
 # ""
 # ""
 "" ""
 % Ź+"

14 2

Ź

%

14.2

S %

+"

— —

|

3.

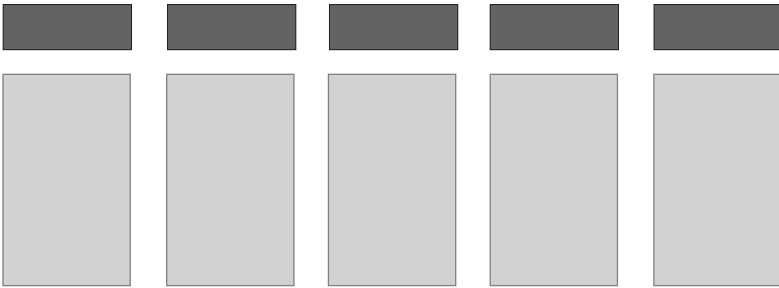



4.

5.

14.2.3 " "

(

%'

1.

)" "

\$

% #'" "

#

\$

\$

%'

#

\$ %



#

\$

% #"

&

2.

!



	" ρ# "

" "

%



4.

14 7

		6C

*

14.3.1

L

L

1.

##S

L

S



#

#

&Z*

SZ*

S" "#

3.

!

14.3.2

1.

šž

#' p#



& p(" .

& " p' ' .

S

%

&ž

' ž

2.

=FH

14.3.3

- 1.

|

JJ

("

? 3 >>

#%

#" " .

2.

JJ

JJ

S



JJ

!

!

JJ

3.

BBF

BBF

!

14.3.4

H

? 3>>#+'*

1.



H5D

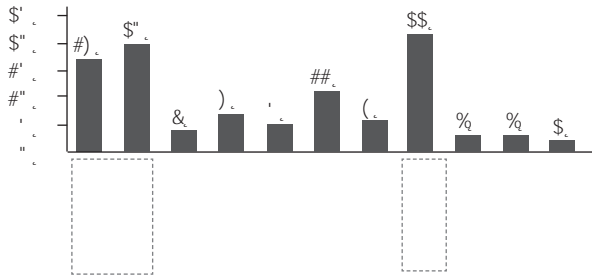

14 4

	#8
	#p## ! ("



3.

4.





5.

14.4

— —

14.4.1

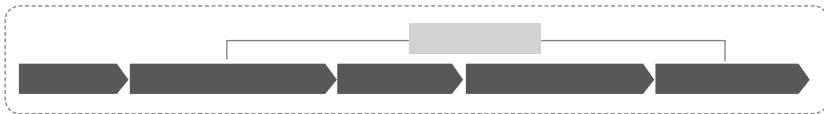

14 7

14.4.2

KPI

=B;

#Z%

%Z

'Z*

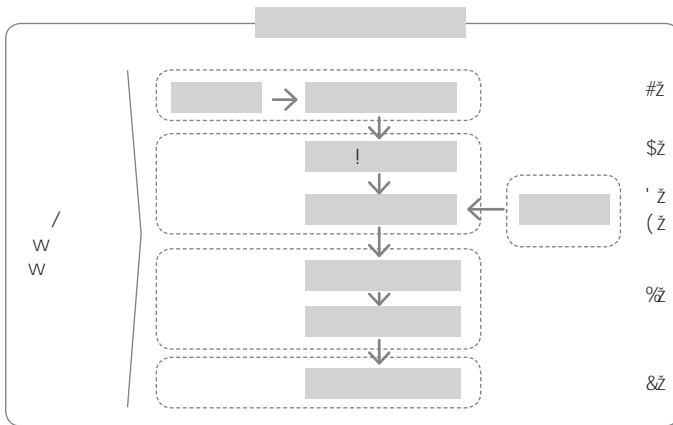

14 8

KPI

14.4.3 KPI

S" ##

=B;



